

Please carefully read this Manual before first operation

PT-B Dental Scaler and Air Polisher Instruction Manual

RxOnly



ZMN-SM-756(FDA) V1.2-20230309
Registration No.: DD 60137494 0001
www.glwoodpecker.com

GUILIN WOODPECKER MEDICAL INSTRUMENT CO., LTD.

Contents

Preface.....	1
1 Introduction.....	1
2 Installation and Operation.....	3
3 Operation guide.....	9
4 Troubleshooting	14
5 Cleaning, disinfection, and sterilization	18
6 Maintenance, storage and transportation	23
7 Environmental protection.....	25
8 After service	25
9 Symbol instruction	25
10 EMC-Declaration of conformity.....	26
11 Statement.....	30

Preface

Guilin Woodpecker Medical Instrument Co., Ltd is a professional manufacturer researching, developing, and producing dental products. Woodpecker owns a sound quality control system and two brands, Woodpecker and DTE. Its main products include dental scaler, dental air polisher, Ultrasurgery, root canal motor, Curing light, dental implant unit, endo motor, etc.

1 Introduction

PT-B dental scaler and air polisher has both ultrasonic system and airpolishing system. It is suitable for periodontal treatment and root canal irrigation in dental clinical treatment. It can remove subgingival and supragingival calculus and plaque, so as to achieve the therapeutic effect of consolidating periodontal tissue.

This device should only be used by doctors or trained professionals in hospitals or clinics.

The device features include:

- 1) Automatically switch the working mode according to the selected handpiece.
- 2) Using Touch LCD screen, function selection and working status indication are concise and clear.
- 3) The rounded vibration trajectory of the tip realizes treatment and polishing at the same time. With small amplitude of tip, achieve painless treatment.
- 4) Titanium alloy tip will not hurt cementum or enamel.
- 5) The automatic frequency tracking system is adopted to automatically search for the best working state, and the machine performance is more stable.
- 6) Water and power can be adjusted.
- 7) Special pharmaceutical products such as hydrogen peroxide, sodium hypochlorite and chlorhexidine can be used in automatic water supply mode to improve clinical therapeutic effect.
- 8) Ultrasonic handpiece LED lights make clinical operation more convenient. Airpolishing handpiece adopts three-section design, which is easy to load and unload, and convenient to clean and maintain.
- 9) The handpiece can be free to plug, and can be sterilized in the environment of 134°C and 0.22MPa pressure.
- 10) Configure wireless multi-function foot switch.

1.1 Product model

PT-B

1.2 Product Configuration

Please refer to the packing list for device configurations.

1.3 Structure and components

It mainly consists of main unit, ultrasonic handpiece, airpolishing handpiece, tips,

nozzle, foot switch, foot switch adapter(optional), powder tank, water bottle, power cable, prophylaxis powder, etc.

1.4 Scope of application

1.4.1 Ultrasound system

① Scaling

- Removal of supragingival calculus
- Removal of stains

② Endo

- Preparation, cleaning and irrigation of root canals
- Retrograde preparation of root canals
- Condensing gutta-percha
- Removal of crown, bridges and restorations

③ Restorative

- Cavity preparation
- Luting inlays and onlays
- Condensing of amalgams

④ Perio

- Scaling and root planing
- Periodontal treatments

1.4.2 Airpolishing system

- Remove dental plaque
- Surface preparation before bonding/cementation of inlays, onlays, crowns and veneers
- Perform the tooth surface preparation before placing the composite restoration.
- Cleaning before sticking orthodontic brackets
- Effectively remove plaque and tartar for orthodontic patients
- Cleaning the implant fixture before loading
- Stain removal for shade determination
- Remove plaque before fluoride treatment
- Remove plaque and tartar before whitening procedure

1.5 Contraindication

1.5.1 The hemophilia patient is forbidden to use this device.

1.5.2 The patients with heart pacemaker are forbidden to use this device.

1.5.3 The doctors with heart pacemaker are forbidden to use this device.

1.5.4 Heart disease patients, pregnant women and children should be cautious to use the device.

1.5.5 Patients with respiratory diseases such as asthma and chronic bronchitis are not allowed to use this device.

1.6 Equipment security classification

1.6.1 Classification by operation mode: Continuous operating device

1.6.2 Type of protection against electric shock: Class I

1.6.3 Degree of protection against electric shock: B type applied part

1.6.4 The contact duration time of applied part:

Tips: Less than 30 minutes

Nozzle: Less than 10 minutes

1.6.5 The temperature of the surface of tips may reach 51°C if it is used at maximum power.

1.6.6 Degree of protection against harmful ingress of water: Ordinary equipment (IPX0). Foot switch is anti-drip device (IPX1).

1.6.7 Degree of safety application in the presence of a flammable anesthetic mixture with air, oxygen, or nitrous oxide: Equipment cannot be used in the presence of a flammable anesthetic mixture with air, oxygen, or nitrous oxide.

1.7 Main technical specification

1.7.1 Main unit input: 100-240V~, 50Hz/60Hz, 1.5-3A

1.7.2 Foot switch adapter(optional)

input: 100-240V~, 50/60Hz, 0.2A

output: 5V --- 1A

Note: If other adapters are used, IEC 60601-1 approved adapters should be selected.

1.7.3 Main vibration offset of output tip (maximum):90μm, deviation: ± 50%

1.7.4 Output tip vibration frequency: 30±5kHz

1.7.5 Output half offset force (maximum):5N deviation: ± 50%

1.7.6 Output power of tip: 3W ~ 20W

1.7.7 Main unit insurance: T3.15AH 250V

1.7.8 Air inlet pressure: 5.5bar ~ 7.5bar (0.55MPa ~ 0.75MPa)

1.7.9 Main unit weight: 2.8kg

1.7.10 Main unit size: length×width×height 350mm×265mm×120mm

1.7.11 Rechargeable lithium battery of foot switch:

Model: 14500

Nominal voltage: 3.6V

Capacity: 750mAh

1.7.12 Water inlet pressure: 1bar~5bar (0.1MPa~0.5MPa)

1.7.13 Software version: V1

1.8 Operation environment

1.8.1 Environment temperature: + 5°C ~ + 40°C

1.8.2 Relative humidity: 30% ~ 80%

1.8.3 Atmospheric pressure: 70kPa ~ 106kPa

1.8.4 Cooling water temperature: +5°C ~ +25°C

1.9 Intended place of use

Professional healthcare facility environment.

1.10 Intended operator

Professional dentist.

2 Installation and Operation

2.1 Main unit and main accessories display

2.1.1 Front view of main unit

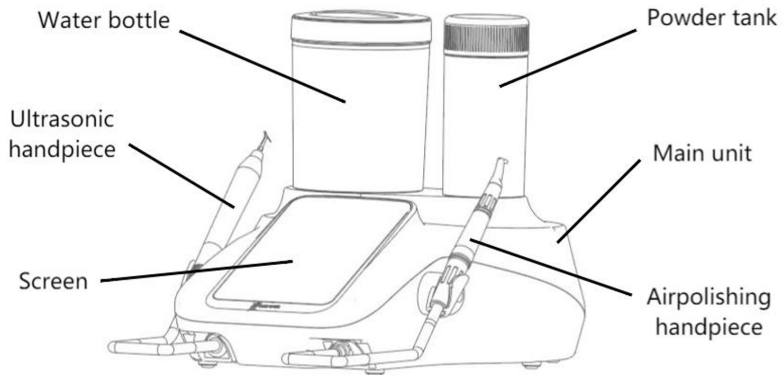

Figure 1 Front view of main unit

2.1.2 Back view of main unit

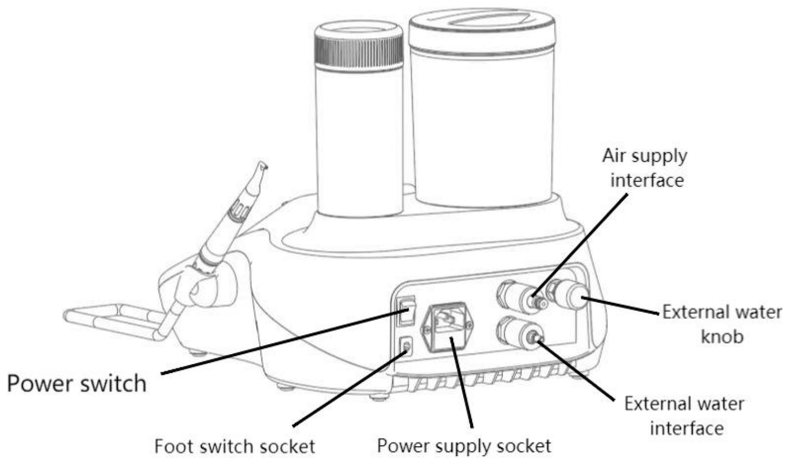
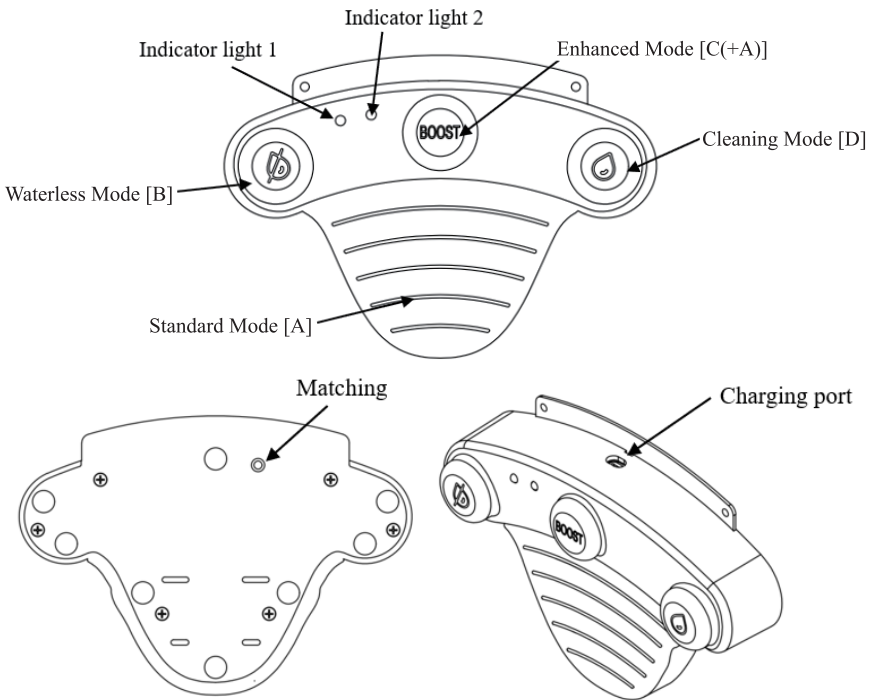
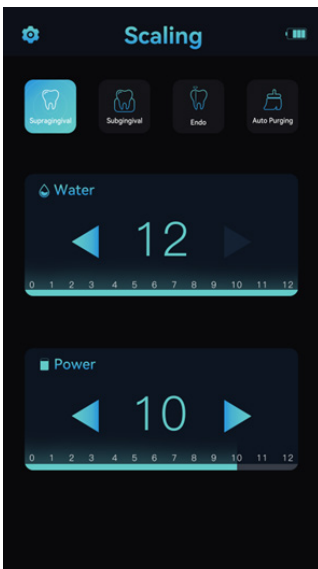









Figure 2 Back view of main unit

2.1.3 Wireless foot switch



2.1.4 Screen



	Purging mode
	Supragingival mode
	Subgingival mode
	Endo mode
	Plus
	Minus
	Setting
	Wireless foot switch battery

[Warning 1] Replacement of lithium batteries when incorrect replacement would result in an unacceptable risk.

[Warning 2] Replacement of lithium batteries by inadequately trained personnel could result in a hazardous situation. If there is any problem with the battery, please contact the dealer or the manufacturer for replacement.

2.1.5 Schematic diagram of handpiece

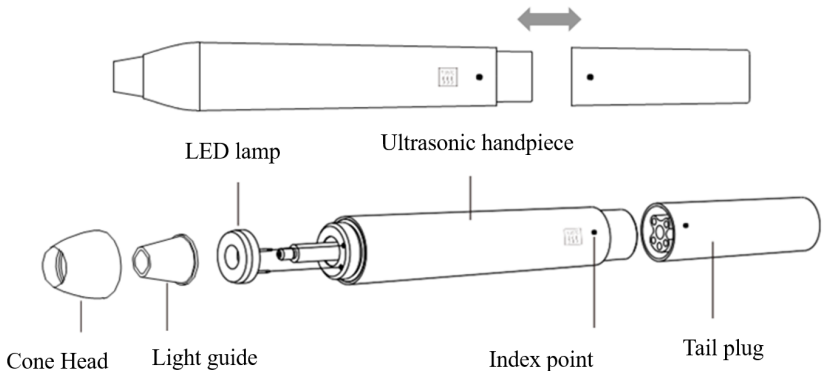

Figure 3 ultrasonic handpiece

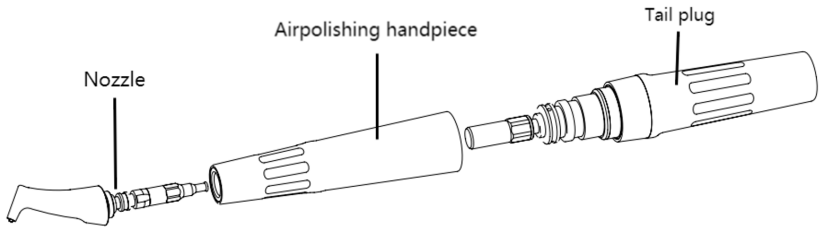

Figure 4 Airpolishing handpiece

2.1.6 Installation diagram of tip

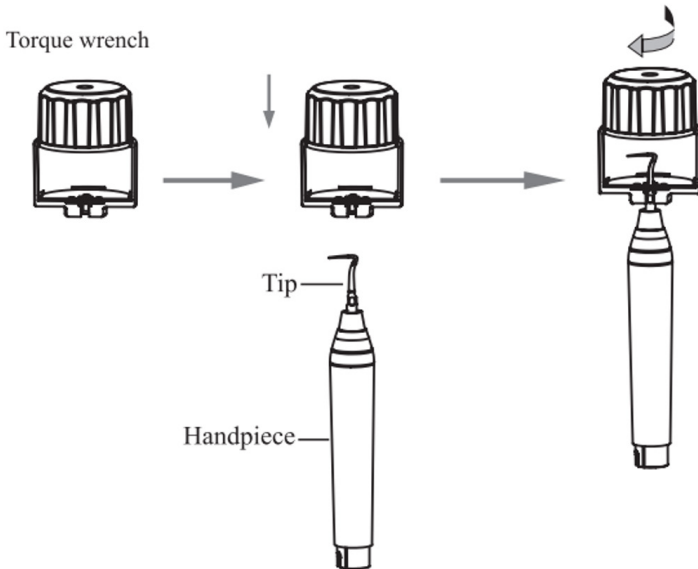

Figure 5 Installation diagram of tip

2.2 Main unit installation

- 1) Open the package, check whether all the accessories of this equipment are complete according to the packing list, and put the main unit on the stable desktop to the operator.
- 2) Take out the external air pipe and connect the air pipe connector to the air supply interface on the back of the main unit; if you need to use external water, connect the water pipe connector to the water source interface on the back of the main unit.
- 3) Turn off the power switch, connect the power cord.

[Warning 1] To avoid the risk of electric shock, this equipment must only be connected to a supply mains with protective earth.

[Warning 2] when the device is connected to the network power supply, do not place or install the product in a place where it is difficult to cut off the network power

supply.

[Warning 3] Unauthorized modification of this equipment is not allowed.

[Warning 4] This equipment cannot be used in areas where liquids may appear on the floor such as emergency rooms or surgical operating rooms.

[Warning 5] This equipment can only be used by professionals with a physician or nurse license.

[Warning 6] The device is expected to be connected to an independent power supply, and the power supply shall be specified as part of the device or the combination of device and power supply shall be specified as the ME system.

[Warning 7] Use of this equipment adjacent to or stacked with other equipment should be avoided because it could result in improper operation. If such use is necessary, this equipment and the other equipment should be observed to verify that they are operating normally.

[Warning 8] Use of accessories, transducers and cables other than those specified or provided by the manufacturer of this equipment could result in increased electromagnetic emissions or decreased electromagnetic immunity of this equipment and result in improper operation.

[Warning 9] To remove the battery of wireless foot switch if the me equipment is not likely to be used for some time.

2.3 Match the foot switch

2.3.1 Click the “Settings” button on the screen to enter the setting interface.

2.3.2 Press and hold the matching button on the underside of the footswitch

2.3.3 Click the “Matching Foot Switch” button on the screen, the main unit starts to automatically match the foot switch, then you can release the matching button on the foot switch.

2.3.4 When the main unit and the wireless foot switch are successfully matched, the screen will automatically jump back to the operation interface, the screen will display the wireless foot switch power icon, and the blue indicator light of the wireless foot switch will be on.

2.3.5 When the matching between the host and the wireless foot switch is unsuccessful, press and hold the matchin button on the foot switch again, and click the “Continue” button to match again.

2.3.6 The wireless foot pedal will automatically shut down after 10min of inactivity and the power icon on the screen will disappear. Or press the waterless mode and cleaning mode buttons at the same time for 3 seconds to turn off the wireless foot pedal. Press the standard mode button for 3 seconds, the pedal starts up and automatically connects to the main unit.

[Tip 1] The device has completed the matching between the host and the foot switch before leaving the factory, and can be used directly after turning on the device. If the matching relationship fails or the foot switch is replaced, the matching can be performed according to the above steps.

[Tip 2] The wireless pedal has two indicator lights. The power indicator is yellow and

green. When the green light is always on, it means that the power is sufficient; when the yellow light is always on, it means that the power is insufficient; Step down the pedal, the power indicator flashes quickly. The connection indicator light is blue, when it is always on, it means that it has been connected to the main unit; when it flashes, it means that it is not connected to the main unit.

[Tip 3] After the wireless pedal is connected to the main unit, the power of the pedal will be displayed on the main unit. The wireless pedal is not connected to the host, and there is no power display on the main unit.

[Tip 4] Charging method: Unplug the silicone plug on the back of foot pedal and connect the charging cable to charge. The flashing yellow light indicates charging, and the steady green light indicates full charge.

2.4 Handpiece connection and disassembly

Take out the ultrasonic handpiece, install the tip on the handpiece with wrench, twist the wrench. Then connect the ultrasonic handpiece with the ultrasonic line and put the handpiece on the bracket on the left side of the main unit.

Take out the airpolishing handpiece, connect the air polishing handpiece with the airpolishing line, and place the handpiece on the bracket on the right side of the main unit.

2.5 Filling with prophylaxis powder

Take out the powder tank and use the three way syringe to blow away the residual powder. Take out the prophylaxis powder, hold the bottle and shake it 3-5 times, then pour the powder into the powder tank. When the powder in the powder tank is used up, please click the “Auto Purging” button twice to remove the compressed air in the 7 powder tank, and then add powder into powder tank. It is unallowed to add powder when in use.

[Tip 1] Do not exceed the maximum (MAX) mark.

[Tip 2] The supragingival powder can only be used in the supragingival powder tank. The subgingival powder can only be used in the subgingival powder tank.

2.6 Filling with water

Take out the water bottle, add purified water (or distilled water) to the water bottle, and then plug the water bottle into the main unit. A small amount of Vaseline can be applied to the seal ring at the bottom of the water bottle to lubricate the seal ring, which is convenient for the water bottle to plug.

3 Operation guide

3.1 Mode selection

The device has preset two modes, namely ultrasonic mode and airpolishing mode. When the ultrasonic handpiece is picked up, the main unit automatically enters the ultrasonic mode, and the airpolishing mode is locked. When the airpolishing handpiece is picked up, the main unit automatically enters the airpolishing mode, and the ultraso-

nic mode is locked.

When two handpieces are placed on the bracket at the same time, the main unit is locked, and there is no response when the foot switch is pressed. When the two handpiece are picked up at the same time, the main unit is also locked, and there is no response when the foot switch is pressed.

3.2 Ultrasonic mode

3.2.1 Ultrasonic scaling

① Turn on the device, pick up the ultrasonic handpiece, and the screen will automatically jump into the ultrasonic mode, select “Supragingival” or “Subgingival” .

Assess the patient’s oral condition, set the power and water level in advance. It is recommended that the power starts from the 3rd gear, and the water volume starts from the 5th gear. According to the sensitivity and comprehensive situation of the patient’s oral cavity, adjust the water and power level at any time during the scaling process.

② Select an appropriate tip as needed and tighten it on the handpiece with the wrench.

③ Press on the foot switch, then the tip vibrates, LED on the head of the handpiece lights, accompanied by water injection . After releasing the foot switch, the vibration and water stops, and the LED light continues to shine for 10 seconds and then goes out.

④ When the machine works normally, the frequency is extremely high. Under the condition of ensuring tip vibrate normal, only side surface of tip should be used to gently touch the tooth surface and there is no obvious fever in tip; Do not use too much force or stay too long when scaling.

⑤ Please keep zero angular contact between the side of tip and the tooth surface during scaling, and let the tip vibrate freely without applying pressure.

⑥ After scaling, let the device work for 30 seconds with the water to clean the handpiece and tip.

3.2.2 Root canal treatment

① Use a root canal wrench to tighten the root canal tip onto the ultrasound handpiece.

② Click the “E” button on the screen to switch to the root canal treatment mode.

③ During clinical scaling, the working tip of the root canal should not be compressed too tightly when it is in the root canal.

④ The root canal tip must be placed in the root canal to activate the foot switch.

⑤ It is recommended to select only 1-5 gears when root canal washing is performed.

3.3 Supragingival air polishing

3.3.1 Assess the patient’s oral condition, set the power and water level in advance, and It is recommended that the power starts from the 2nd gear, and the water volume starts from the 3rd gear. According to the sensitivity and comprehensive situation of the patient’s oral cavity, adjust the water and power level at any time during the sca-

ling process.

3.3.2 Before the treatment, please spray in the external container for 1-3 seconds in advance to ensure that the gas and water are evenly sprayed.

3.3.3 Before air polishing, please wear goggles and veil. Users should wear goggles or protective masks.

3.3.4 Hold the handpiece like holding a pen.

3.3.5 Make the nozzle align with the tooth surface. It is recommended that the nozzle outlet keep a distance of 3-5mm from the tooth surface. It is recommended that the air polishing direction and the tooth surface show an angle of 30 °-60 °, as shown in figure 6.

3.3.6 Use the high-speed evacuation equipment on the dental comprehensive treatment machine to absorb the air/powder mixture reflected from the tooth surface during treatment.

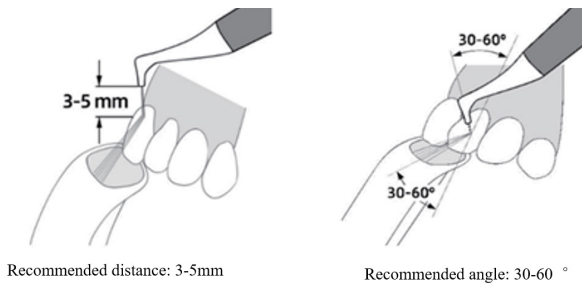

Figure 6 schematic diagram of grit blasting on gum

3.4 Subgingival air polishing

3.4.1 When the depth of the patient's periodontal pocket exceeds 4mm, subgingival airpolishing is recommended.

3.4.2 Install the nozzle before use, take out the nozzle assemble the nozzle to the end of the subgingival handpiece. Rotate the nozzle nut to the head handpiece first, and then lock the nozzle with a wrench, as shown in Figure 7.

3.4.3 Assess the periodontal condition of patients and set the power and water level in advance. It is recommended that the power starts from the 1st gear and the water starts from the 3rd gear. Adjust the water and power level at any time during the scaling process.s according to the periodontal sensitivity and oral comprehensive situation of patients.

3.4.4 Hold the handpiece like holding a pen.

3.4.5 It is recommended to use the nozzle to remove the plaque of the 4-9mm depth periodontal pocket, pull up and down when using.

3.4.6 It is not allowed to polishing the periodontal pocket at each point for more than 5 seconds. [Tip 3] It is forbidden to pull out the handpiece in the working state.

[Tip 4] When subgingival airpolishing, it's just allowed use subgingical powder, and misusing powder may cause harm to patients.

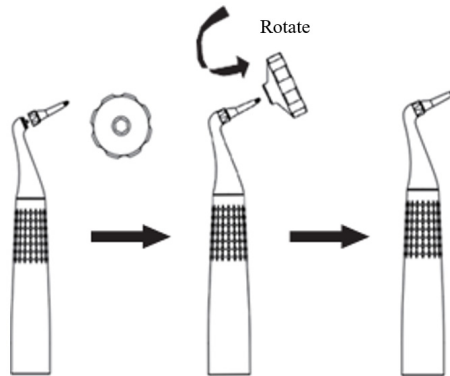

Figure 7 Nozzle locking

3.5 Wireless multi-function foot switch

The multi-function foot switch is as shown in the figure, and the functions of each button are as follows.

Button	Working mode	Function	
		Ultrasonic	Airpolishing system
A	Standard	Vibration + water	Air, powder + water
B	Waterless	Vibration	Air
C(+A)	Enhance [Note]	Power increases by three levels	Air pressure increases by three levels
D	Cleaning	Water	Air+water

[Note] In the Enhance mode, the power/air pressure is increased by three levels based on the original level, and the maximum is level 12. When the pedal button C is released, the gear position is automatically restored to the previously set gear position.

3.6 Setting

3.6.1 Click “setting” button on the screen and enter setting interface.

3.6.2 Click “language switch” button and change the language.

3.6.3 Click “water temperature” button and change the water temperature. There are 5 gears of temperature.

0	1	2	3	4
No heating	25°C	30°C	35°C	40°C

[Tip 11] Because the water will transfer part of the heat when it flows in the pipeline, the actual output water temperature may be slightly lower than the set temperature. Affected by external conditions such as ambient temperature, the speed and absolute value of heat dissipation are different, so the output water temperature may fluctuate. The above are normal phenomena.

3.6.4 Click the water supply mode setting switch button to switch the water supply

mode, which are the “Bottle” mode and the “External water” mode. When using a water bottle for water supply, it is necessary to install the water bottle, and change the water volume by clicking the plus and minus buttons of the water level on the screen. When using external water for water supply, it is necessary to connect the external water, and adjust the water volume through the water volume adjustment knob on the back of the main unit.

3.6.4 Click the Reset button to restore all set parameters to their default values.

3.7 Maintenance

3.7.1 Air polishing handpiece

3.7.1.1 Remove the air polishing handpiece, loosen the handpiece head and pull out the handpiece head (For subgingival handpiece, the nozzle needs to be removed in advance), as shown in figure 8.

3.7.1.2 Align the handpiece head with a three way syringe and blow away the residual powder in the handpiece.

3.7.1.3 Blow the front and rear ends of the handpiece with a three way syringe.

3.7.1.4 If the handpiece is blocked, use needle to dredge it.

3.7.1.5 Handpieces, water bottles and powder tanks should not be maintained when they are being used.

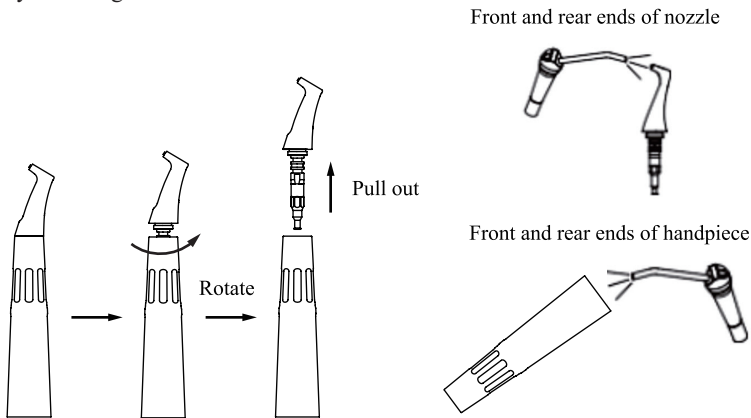

Figure 8 handpiece cleaning diagram

3.7.2 Powder tank

3.7.2.1 It is recommended to estimate the amount of prophylaxis powder before use. It is easy to cause blocked that leaving extra powder in the powder tank for a long time because the powder will clump in a humid environment. Therefore, please pour out the powder remaining in the powder tank after use.

3.7.2.2 Before turning off the device every day, please use an air gun to blow off the powder remaining in the powder tank, and blow off the powder on the threads of the powder tank and the threads of the powder tank cover. The powder tank that have not been cleaned for a long time may reduce the efficiency of airpolishing, and the

residual powder at the threads will affect the sealing performance of the powder tank and the smoothness of the upper cover screwing.

3.7.3 Daily maintenance

3.7.3.1 Before and after using airpolishing system, please click the “Purging Mode” button on the main unit and the device will enter into purging mode. The purging mode duration is 20 seconds, and then stops automatically.

[Tip 3] If powder needs to be added during use, please click the “purging mode” button to release the high-pressure air in the powder tank to prevent powder spraying from the bottom of the powder tank when the powder tank is unplugged.

3.7.3.2 If the liquid medicine is used during the treatment, then after the treatment is completed, you must fill the water bottle with pure water (or distilled water), pick up the handpiece and press the foot switch to let the water flow out of the handpiece to flush the pipe for at least 1 minute. The chemical liquid remaining in the pipeline will cause corrosion of metal parts such as joints and solenoid valves.

4 Troubleshooting

4.1 Description of Wearing Parts

1. The O-rings at the joint of the handpiece: the connection position of the handpiece may be damaged due to its frequent unplugging, so it needs to be replaced as needed from time to time.

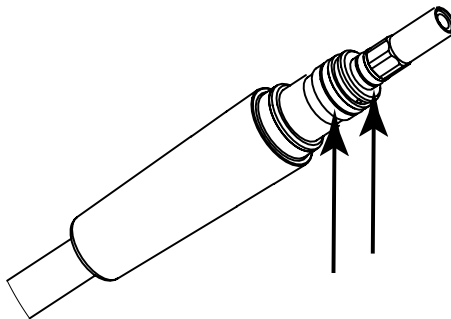

2. Sand pipe at the bottom of the main engine: there is an on-off valve to control the sand powder on and off at the bottom of the main engine, and the sand pipe at the on-off valve may be damaged for a long time; it needs to be replaced after damage.

Expected life of sand pipe at the bottom:

Frequency of use	Expected life
1 ~ 2 times/day	4 ~ 6 years
3 ~ 4 times/day	2 ~ 4 years
5 times or more/day	1-2 years

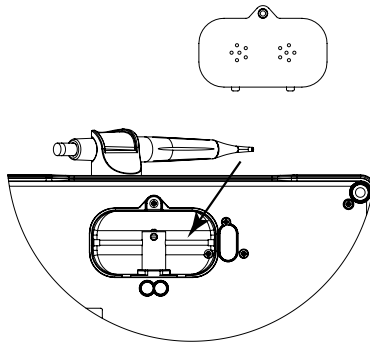

3. The sandblasting tail line of the main engine: there is a sand hose in the tail line of the sandblasting handpiece, and the wear of the hose for a long time may lead to air leakage and sand leakage of the tail line; it needs to be replaced after damage.

Expected life of sand pipe at the bottom:

Frequency of use	Expected life
1 ~ 2 times/day	4 ~ 6 years
3 ~ 4 times/day	2 ~ 4 years
5 times or more/day	1-2 years

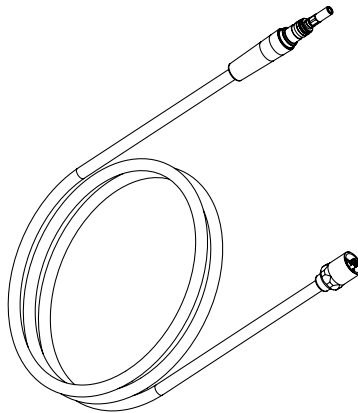

4. The O-rings in the rest of the mainframe may also be damaged due to wear and tear, which need to be replaced after the damage.

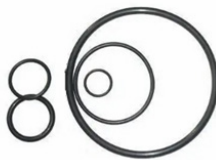

4.2 Troubleshooting

Fault	Possible cause	Solutions
There is a pop-up prompt “Heating malfunction. Please turn off heating system.”	The heating system is abnormal and cannot conduct heating normally.	Enter the air polishing interface and set the temperature to Level 0. If other functions perform normally, please contact local dealer or Woodpecker to replace the heater.
There is a pop-up prompt “Grounding fault, please turn off heating system and check the circuit grounding condition of your clinic.”	The clinic power supply is not grounded.	Enter the air polishing interface and set the temperature to Level 0. If other functions perform normally, it’s recommended to use a grounded power supply.
There is a pop-up prompt “Insufficient Air Pressure.”	Air source is not connected.	Check the air source connection and ensure that the pressure meets the requirement of machine operation.
Press foot switch, the tip does not vibrate and no water sprays	Poor contact of power plug.	Plug in the power plug well
	Poor contact of foot switch.	Plug in foot switch plug well.
	Bracket switch does not pop up.	Toggle bracket switch to make it pop up smoothly.
Press foot switch, the tip does not vibrate but water sprays out.	The tip is not tightened.	Tighten work tip
	The connection plug between the tail line and the circuit board is loose.	Contact local distributors or manufacturer.
	Handpiece failure.	Contact local distributors or manufacturer.
Press foot switch, the tip vibrates but no water spray.	Impurities in solenoid valve.	Contact local distributors or manufacturer.
	Waterway blockage.	Use three-way syringe to dredge waterway
After power-off, there is still water spray.	Impurity in the solenoid valve.	Contact local distributors or manufacturer.

There is air flow but no water spray.	Unconnected air source or low air pressure ($\leq 3\text{bar}$).	Check the air connection and ensure that the pressure meets the requirements of the device (5bar-7bar).
	Handpiece blocked.	Use nozzle to dredge handpiece.
	Tail line blocked.	Contact local distributors or manufacturer.
	The internal pipeline of the main unit is blocked.	Contact local distributors or manufacturer.
	Solenoid valve failure.	Contact local distributors or manufacturer.
There is air and water spray, but no powder.	The powder adheres to the inner wall of the powder tank after being damp, which affects the normal flow of the powder.	Disassemble the powder tank and reinstall it after cleaning and drying.
	Incorrect match between powder tank and prophylaxis powder.	The supragingival powder tank should be match with supragingival powder. The subgingival powder tank should be match with subgingival powder.
There is air spray but no water.	Solenoid valve failure.	Contact local distributors or manufacturer.
	Solenoid Valve blocked due to impurities.	Open the main unit dredge solenoid valve or contact local distributors or manufacturer.
There is no air and water spray.	Abnormal foot switch connection.	Reconnect foot switch.
	Foot failure.	Repair or replace foot switch.
Powder tank leakage	Seal ring damaged.	Replace seal ring.
	The upper cover of the powder tank is not screwed in place.	Re-screw the upper cover.
Airpolishing handpiece leakage.	Tail line seal ring damaged, deformed or missing.	Replace seal ring.
Handpiece plug difficult.	Handpiece snap ring deformation	Replace snap ring.

Note: If the fault cannot be removed, please contact your local distributor or manufacturer.

5 Cleaning, disinfection, and sterilization

Drain the water tubing-dry mode

After each use, the water in the water tubing should be drained to avoid the retention of residual water and the growth of bacteria. The method of draining the water in the tubing is as follows:

(1) In ultrasonic mode

a. If water bottle is used for water supply:

After treatment, remove the ultrasonic handpiece and water bottle, and pour out the remaining liquid in the water bottle. Touch the “Auto Purging” button on the screen and step on the D button on the pedal. At this time, you can release the pedal and it will stop automatically after 30 seconds. Touch the “Auto Purging” button again and repeat the above steps for 3 times to drain the water in the tubing.

b. If external water supply is used:

After treatment, turn off the external water switch, remove the ultrasonic handpiece, 17 touch the “Auto Purging” button on the screen and step on the D button on the pedal. At this time, you can release the pedal and it will stop automatically after 30 seconds. Touch the “Auto Purging” button again and repeat the above steps for 3 times to drain the water in the tubing.

(2) In Airpolishing mode

Remove the sand blasting handpiece and water bottle, pour out the remaining water in the water bottle or turn off the external water switch, adjust all gears to the maximum level, press the pedal continuously for 1 min, then release the pedal to drain the water in the tubing.

The cleaning, disinfection and sterilization of the Ultrasonic handpiece, scaling tip, Air polishing handpiece, nozzle, and wrench are as follows.

Unless otherwise stated, they will be hereinafter referred to as “products.”

Warnings

- 1) The use of strong detergent and disinfectant (alkaline pH>9 or acid pH<5) will reduce the life span of products. And in such cases, the manufacturer takes no responsibility.
- 2) Do not clean the Ultrasonic handpiece with ultrasound cleaning machine.
- 3) This device shall not be exposed to high temperature above 138.
- 4) Please note that disinfection is not a substitute for cleaning or sterilization. Both cleaning and sterilization must be performed after each use.

Reprocessing limit

The products have been designed for a large number of sterilization cycles. The materials used in manufacture were selected accordingly. However with every renewed preparation for use, thermal and chemical stresses will result in aging of the

products. The maximum number of sterilizations for the Ultrasonic handpiece is 600 times. For Air polishing handpiece, it is 1000 times. For tips, it is 300 times. And for wrench, it is 1000 times.

5.1 Initial processing

5.1.1 Processing principles

It is only possible to carry out effective sterilization after the completion of effective cleaning and disinfection. Please ensure that, as part of your responsibility for the sterility of products during use, only sufficiently validated equipment and product-specific procedures are used for cleaning/disinfection and sterilization, and that the validated parameters are adhered to during every cycle.

Please also observe the applicable legal requirements in your country as well as the hygiene regulations of the hospital or clinic, especially with regard to the additional requirements for the inactivation of prions.

5.1.2 Post-operative treatment

The post-operative treatment must be carried out immediately, no later than 30 minutes after the completion of the operation. The steps are as follows:

1. Let the PT-B Dental Scaler and Air Polisher work for 20-30 seconds under irrigation mode to flush the Ultrasonic handpiece, tip, air polishing handpiece and nozzle.
2. Remove the Ultrasonic handpiece and air polishing handpiece from the PT-B Dental Scaler and Air Polisher, and rinse away the dirt on the surface of product with pure water (or distilled water/deionized water).
3. Dry the product with a clean, soft cloth and place it in a clean tray.

5.2 Transportation

Safely store and transport the device to the reprocessing area to avoid any damage and contamination to the environment.

5.3 Preparation before cleaning

The devices must be reprocessed in a disassembled state. Steps are as follows: Tools: 5# torque wrench (or endo wrench), tray, soft brush, clean and dry soft cloth

1. Remove the tip from the Ultrasonic handpiece with 5# torque wrench provided by Guilin Woodpecker Medical Instrument Co., Ltd, and then put the tip and wrench into a clean tray.
2. Unscrew the nipple of handpiece counterclockwise, remove the sealing ring, light pipe, and LED lamp, and put them in the tray.
3. Remove the nozzle from air polishing handpiece, and then put them into a clean tray.
4. Use a clean soft brush to carefully brush the joints between handpiece and the connector of cable, front thread, horn, nipple, seal ring, light pipe, LED lamp, and nozzle until the dirt on surface is not visible. Then use soft cloth to dry the handpiece and accessories and put them into a clean tray. The cleaning agent can be pure

water, distilled water or deionized water.
For disassembling steps see figure 9 below for details.

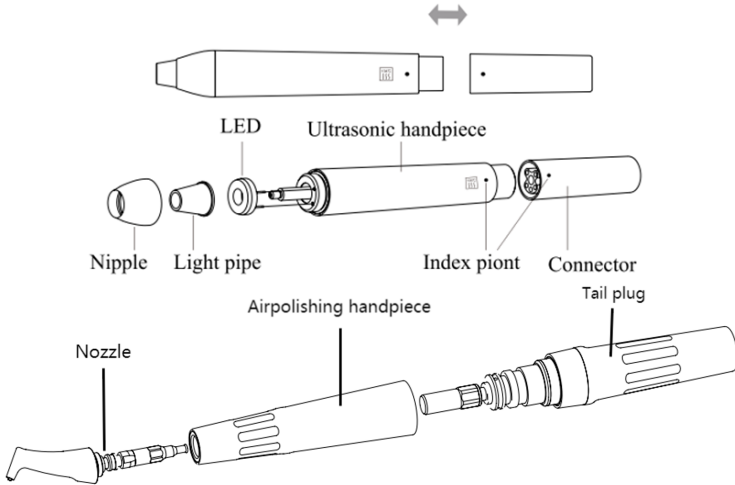

Figure 9 Ultrasonic handpiece and Air polishing handpiece

5.4 Cleaning

The cleaning should be performed no later than 1 hour after the operation. Preference is given to automated reprocessing methods, especially due to the better standardizing potential and industrial safety.

Automated cleaning

- The cleaner is proved to be valid by CE or FDA certification in accordance with ISO 15883.
- There should be a flushing connector connected to the inner cavity of the product.
- The cleaning procedure is suitable for the product, and the irrigating period is sufficient.
- Do not clean the Ultrasonic handpiece with ultrasound.

1. Carefully place the product into the washer-disinfector. Fixation of product is needed only when the product is removable in the device. The products are not allowed to contact each other.

2. Connect the interface of the nozzle to the appropriate flushing connector of the automatic washer-disinfector.

3. Start the program of the washer-disinfector:

-3 min pre-cleaning with cold purified water

-emptying

-5 min washing with Metrex Empower in deionized water (<45°C)

Cleaning Agent: Metrex EmPower Concentration: 1:128~1:512

Temperature: 20°C~40°C

-emptying

-1 min intermediate rinsing with cold deionized water

-emptying

-1 min intermediate rinsing with cold deionized water

-Emptying

Notes

a) The cleaning agent does not have to be pure water. It can be distilled water, deionized water or multi-enzyme. But please ensure that the selected cleaning agent is compatible with the product.

b) In washing stage, the water temperature should not exceed 45 °C, otherwise the protein will solidify and would be difficult to remove

5.5 Disinfection

Notes

1) According to ISO 17664 no manual reprocessing methods are required for these devices. If a manual reprocessing method has to be used, please validate it prior to use.

2) The washer-disinfector is proved to be valid by CE or FDA certification in accordance with ISO 15883.

3) Regularly repair and inspect the disinfector. 20 Disinfection must be performed no later than 2 hours after the cleaning phase. Automated disinfection is preferred if conditions permit.

5.6 Drying

Automated Drying: Drying of outside of instrument through drying cycle of washer/disinfector. If needed, additional manual drying can be performed through lint free towel. If using sterile compressed air for drying insufflate cavities of instruments, the air must be filtered by HEP.

Manual drying:

If your cleaning and disinfection process does not have an automatic drying function, dry it after cleaning and disinfection.

Methods

1. Spread a clean white paper (white cloth) on the flat table, point the product against the white paper (white cloth), and then dry the product with filtered dry compressed air (maximum pressure 3 bar). Until no liquid is sprayed onto the white paper (white cloth), the product drying is completed.

2. It can also be dried directly in a medical drying cabinet (or oven). The recommended drying temperature is 80°C~120°C and the time should be 15~40 minute.

Notes

a) The drying of product must be performed in a clean place.

b) The equipment used should be inspected and maintained regularly.

5.7 Inspection and maintenance

In this chapter, we only check the appearance of the product. After inspection, if there is no problem, the Ultrasonic handpiece should be immediately reassembled. Install the sealing ring, LED, light guide, and cone head in sequence to the Ultrasonic handpiece, and then tighten the cone head clockwise. The nozzle should be immediately inserted into air polishing handpiece.

5.7.1 Check the product. If there is still visible stain on the product after cleaning/disinfection, the entire cleaning/disinfection process must be repeated.

5.7.2 Check the product. If it is obviously damaged, smashed, detached, corroded or bent, it must be scrapped and not allowed to continue to be used.

5.7.3 Check the product. If the accessories are found to be damaged, please replace them before use. And the new accessories for replacement must be cleaned, disinfected and dried.

5.7.4 If the service time (number of times) of the product reaches the specified service life (number of times), please replace it in time.

5.8 Packaging

Install the cleaned and dried product and quickly package it in a FDA-cleared wrap or pouch or other method of maintaining sterility for the sterilization.

Notes

- a) The packaging environment and related tools must be cleaned regularly to ensure cleanliness and prevent the introduction of contaminants.
- b) Avoid contact with parts of different metals when packaging.

5.9 Sterilization

Use the following steam sterilization procedures (fractional pre-vacuum procedure*) for sterilization:

1. The steam sterilizer complies with EN13060 or is certified according to EN 285 to comply with ISO 17665.

2. The sterilization time is 4 minutes at a temperature of 132 °C and a pressure of 2.0 bar ~2.3 bars, with drying time of 20 minutes. Notes

a) Only products that have been effectively cleaned and disinfected are allowed to be sterilized.

b) Before using the sterilizer for sterilization, read the Instruction Manual provided by the equipment manufacturer and follow the instructions.

c) Do not use hot air sterilization and radiation sterilization as this may result in damage to the product.

d) Please use the recommended sterilization procedures for sterilization. It is not recommended to sterilize with other sterilization procedures such as ethylene oxide, formaldehyde and low temperature plasma sterilization. The manufacturer assumes no responsibility for the procedures that have not been recommended. If you use the sterilization procedures that have not been recommended, please adhere to related effective standards and verify the suitability and effectiveness.

*Fractional pre-vacuum procedure = steam sterilization with repetitive pre-vacuum. The procedure used here is to perform steam sterilization through three pre-vacuums.

5.10 Storage

5.10.1 Store in a clean, dry, ventilated, non-corrosive atmosphere with a relative humidity of 10% to 93%, an atmospheric pressure of 70KPa to 106KPa, and a temperature of -20 °C to +55 °C.

5.10.2 After sterilization, the product should be packaged in a medical sterilization bag or a clean sealing container, and stored in a special storage cabinet. The storage time should not exceed 7 days. If it is exceeded, it should be reprocessed before use.

Notes

- a) The storage environment should be clean and must be disinfected regularly.
- b) Product storage must be batched, marked and recorded.

5.11 Transportation

5.11.1 Prevent excessive shock and vibration during transportation, and handle with care.

5.11.2 It should not be mixed with dangerous goods during transportation.

5.11.3 Avoid exposure to sun or rain or snow during transportation. The cleaning and disinfection of main unit are as follows.

- Before each use, wipe the surface of the machine and the tail cord of the handpiece with a soft cloth or paper towel soaked in 75% medical alcohol. Repeat the wipe for at least 3 times.
- Before each use, please let the PT-B Dental Scaler and Air Polisher work under irrigation mode for 20-30s, then install the handpiece.
- After each use, please let the PT-B Dental Scaler and Air Polisher work under irrigation mode for 20-30s, then remove the handpiece.
- After each use, wipe the surface of the device and the tail cord of the handpiece with a soft cloth soaked in clean water (distilled or deionized water) or a clean disposable wipe. Repeat the wipe for at least 3 times.

6 Maintenance, storage and transportation

6.1 Maintenance

6.1.1 It is recommended to install air drying equipment (such as freezing dryer) in advance before using air polishing device. And check drying equipment every day to ensure it work normally. Otherwise it may be easy to cause prophylaxis powder agglomerating. And the agglomerating will cause the device or handpiece blocked.

6.1.2 Check sealing ring on the handpiece, tail line, powder tank, water bottle regularly. If finding defects such as rupture, deformation or falling off, please refer to the instructions and replace them in time, the accessories are equipped with sealing rings of corresponding specifications.

6.1.3 Check the air inlet interface filter once a month to confirm whether there is impurity in the filter. If there is impurity, replace the filter in time, and check the cleanliness of the air compressor and the environment where it is located. If there is no impurity, it is recommended to replace the filter every 24 months. Spare filters are included in accessories. The way to replace filter are shown in Figure 10.

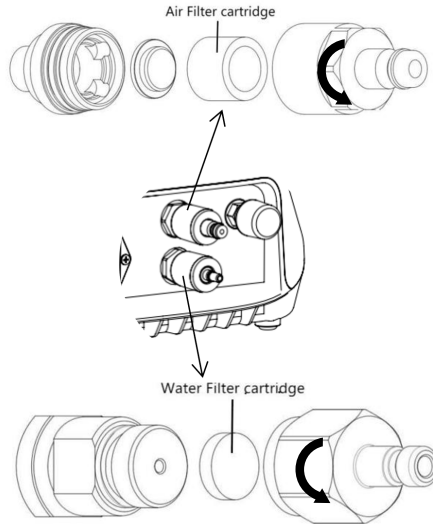

Fig. 10 schematic diagram of filter replacement

6.1.4 When the battery of the foot switch cannot be charged, or the foot switch cannot be switched on and the battery needs to be replaced, it must be sent back to the manufacturer or replaced by the service personnel authorized by the manufacturer.

6.2 Storage

6.2.1 This device should be carefully placed away from the source, and should be installed or stored in a cool, dry and ventilated place.

6.2.2 Do not mix with toxic, corrosive, flammable and explosive articles during storage.

6.2.3 The product should be stored in an environment where the relative humidity is 10% ~ 93%, the atmospheric pressure is 70kPa ~ 106kPa, and the temperature is -20°C ~ + 55°C.

6.2.4 When this equipment is not in use for a long time, it should be powered on and ventilated once a month, at least five minutes each time.

6.3 Transportation

6.3.1 Excessive impact and shake should be prevented during transport. Lay it carefully and lightly.

6.3.2 Do not put it together with dangerous goods during transport.

6.3.3 Avoid being exposed to sun, rain, and snow during transport.

7 Environmental protection

Part	Toxic or harmful substances or elements					
	Pb	Hg	Cd	Cr6+	PBB	PBDE
Main unit	○	○	○	○	○	○
andpiece	○	○	○	○	○	○
Tip	○	○	○	○	○	○
Nozzle	○	○	○	○	○	○
Foot pedal	○	○	○	○	○	○
Mechanical elements, including bolts, nuts, washers, etc.	○	○	○	○	○	○

○: Indicates that the content of the toxic substance in all homogeneous materials of the part is below the limit requirement stipulated in SJ/T-11363-2006 Limit Requirements for Toxic and Hazardous Substances in Electronic Information Products.
 ×: indicates that the content of the toxic substance in at least one of the homogeneous materials of the part exceeds the limit requirement specified in SJ/T-11363-2006.
 Please dispose according to the local laws or consult with dealer from whom you purchased it about waste disposal.

8 After service

We offer one year free repair to the equipment according to the warranty card. The repair of the equipment should be carried out by professional technician. We are not responsible for any irretrievable damage caused by non-professional person. This product is a precision equipment. If there is problem that needs to be repaired, returned to Woodpecker or handled by professionals is recommended. If any component part needs to be replaced, please contact Woodpecker for relevant information. Please use accessories or component parts provided or approved by Woodpecker. Using other accessories or component parts may cause equipment failure and unacceptable risks.

9 Symbol instruction



Manufacturer



Consult the accompanying documents

IPX0

Ordinary equipment



Recovery



Appliance compliance WEEE directive



Date of manufacture



B type applied part

IPX1

Anti-drip equipment



Handle with care



Keep dry



Alternating current



Used indoors only



Protective earthing



Foot pedal



Irrigation mode



Anhydrous mode



Sterilization under high temperature



Storage condition, air pressure limit: 70kPa ~ 106kPa

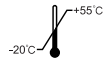

Storage condition, temperature limit: -20°C ~ +55°C



Storage condition, humidity limit: 10% ~ 93%



Federal law restricts this device to sale by or on the order of a dentist.

10 EMC-Declaration of conformity

A list of all cables are replaceable by the RESPONSIBLE ORGANIZATION:

Port No.	Name	Type*	Cable maximum lengths
1	Enclosure	N/E	—
2	AC Mains	AC power port	3m
3	Ultrasonic handpiece Cable	PATIENT COU-PLING PORT	1.7m

Guidance and manufacturer's declaration - electromagnetic emissions

The model PT-B is intended for use in the electromagnetic environment specified below. The customer or the user of the model PT-B should assure that it is used in such an environment.

Emissions test	Compliance	Electromagnetic environment - guidance
RF emissions CISPR 11	Group 1	The model PT-B RF energy only for its internal function. Therefore, its RF emissions are very low and are not likely to cause any interference in nearby electronic equipment.

RF emissions CISPR11	Class B	The model PT-B RF energy only for its internal function. Therefore, its RF emissions are very low and are not likely to cause any interference in nearby electronic equipment.
Harmonic emissions IEC 61000-3-2	Class A	
Voltage fluctuations / flicker emissions IEC 61000-3-3	Complies	

Guidance & Declaration — electromagnetic immunity

The model PT-B 1s intended for use 1n the electromagnetic environment specified below. The customer or the user of the model PT-B should assure that It is used in such an environment.

Immunity test	IEC 60601 test level	Compliance level	Electromagnetic environment - guidance
Electrostatic discharge (ESD) IEC 61000-4-2	± 8 kV contact ± 15 kV air	± 8 kV contact ± 15 kV air	Floors should be wood, concrete or ceramic tile If floors are covered with synthetic material, the relative humidity should be at least 30 %.
Electrical fast transient/burst IEC 61000-4-4	±2kV for power supply lines ±1kV for Input/output lines	± 2kV for power supply lines ± 1kV for interconnecting cable	Mains power quality should be that of a typical commercial or hospital environment.
Surge IEC 61000-4-5	± 1 kV line to line ± 2 kV line o earth	Line-to-line--- ± 0,5 kV, ± 1 kV Line-to-ground--- ± 0,5 kV, ± 1 kV, ± 2 kV	Mains power quality should be that of a typical commercial or hospital environment.
Voltage dips, short interruptions and voltage variations on power supply input lines IEC 61000--11	0 % UT; 0,5 cycle At 0°, 45°, 90°, 135°, 180°, 225°, 270° and 315° 0 % UT; 1 cycle and 70 % UT; 25/30 cycles Single phase: at 0° 0 % UT; 250/300 cycle	0 % UT; 0,5 cycle At 0°, 45°, 90°, 135°, 180°, 225°, 270° and 315° 0 % UT; 1 cycle and 70 % UT; 25/30 cycles Single phase: at 0° 0 % UT; 250/300 cycle	Mains power quality should be that of a typical commercial or hospital environment If the user of the model require continued operation during power mains interruptions, it is recommended that the model be powered from an uninterruptible power adapter or a battery.

Power frequency (50/60 Hz) magnetic field IEC 61000-4-8	30 A/m, 50 Hz and 60 Hz	30 A/m, 50 Hz and 60 Hz	Power frequency magnetic fields should be at levels characteristic of a typical location in a typical commercial or hospital environment.
NOTE UT is the ac mains voltage prior to application of the test level.			

Guidance & Declaration - Electromagnetic immunity			
The model PT-B is intended for use in the electromagnetic environment specified below. The customer or the user of the model PT-B should assure that it is used in such an environment.			
Immunity test	IEC 60601 test level	Compliance level	Electromagnetic environment - guidance

<p>Conducted RF IEC 61000-4-6 Conducted RF IEC 61000-4-6 Radiated RF IEC 61000-4-3</p>	<p>3 V, 0.15 MHz – 80 MHz, 6 V in ISM bands between 0.15 MHz – 80 MHz, 80 % AM at 1 kHz 3 V/m and 10 V/m, 80 MHz – 2,7 GHz, 80 % AM at 1 kHz 385 MHz, pulse modulation 18 Hz, 27 V/m; 450 MHz, FM +/- 5 kHz deviation 1 kHz sine, 28 V/m; 710 MHz, 745 MHz, 780 MHz, pulse modulation 217 Hz, 9 V/m; 810 MHz, 870 MHz, 930 MHz, pulse modulation 18 Hz, 28 V/m; 1,720 MHz, 1,845 MHz, 1,970 MHz, pulse modulation 217 Hz, 28 V/m; 2,450 MHz, pulse modulation 217 Hz, 28 V/m; 5,240 MHz, 5,500 MHz, 5,785 MHz, pulse modulation 217 Hz, 9 V/m</p>	<p>3 V, 0.15 MHz – 80 MHz, 6 V in ISM bands between 0.15 MHz – 80 MHz, 80 % AM at 1 kHz 3 V/m and 10 V/m, 80 MHz – 2,7 GHz, 80 % AM at 1 kHz 385 MHz, pulse modulation 18 Hz, 27 V/m; 450 MHz, FM +/- 5 kHz deviation 1 kHz sine, 28 V/m; 710 MHz, 745 MHz, 780 MHz, pulse modulation 217 Hz, 9 V/m; 810 MHz, 870 MHz, 930 MHz, pulse modulation 18 Hz, 28 V/m; 1,720 MHz, 1,845 MHz, 1,970 MHz, pulse modulation 217 Hz, 28 V/m; 2,450 MHz, pulse modulation 217 Hz, 28 V/m; 5,240 MHz, 5,500 MHz, 5,785 MHz, pulse modulation 217 Hz, 9 V/m</p>	<p>Portable and mobile RF communications equipment should be used no closer to any part of the models PT-B, including cables, than the recommended separation distance calculated from the equation applicable to the frequency of the transmitter. Recommended separation distance $d=1.2 \times P^{1/2}$ $d=2 \times P^{1/2}$ $d=1.2 \times P^{1/2}$ 80 MHz to 800 MHz $d=2.3 \times P^{1/2}$ 800 MHz to 2.7 GHz where P is the maximum output power rating of the transmitter In watts (W) according to the transmitter manufacturer and d is the recommended separation distance in meters (m). Field strengths from fixed RF transmitters, as determined by an electromagnetic site survey, a should be less than the compliance level in each frequency range. b Interference may occur In the vicinity of equipment marked with the following symbol: </p>
--	---	---	--

NOTE 1 At 80 MHz - 800 MHz, the higher frequency range applies.
NOTE 2 These guidelines may not apply in all situations. Electromagnetic propagation is affected by absorption and reflection from structures, objects and people.

a Field strengths from fixed transmitters, such as base stations for radio (cellular/cordless) telephones and land mobile radios, amateur radio, AM and FM radio broadcast and TV broadcast cannot be predicted theoretically with accuracy. To assess the electromagnetic environment due to fixed RF transmitters, an electromagnetic site survey should be considered. If the measured field strength in the location in which the model is used exceeds the applicable RF compliance level above, the model should be observed to verify normal operation. If abnormal performance is observed, additional measures may be necessary, such as reorienting or relocating the model.
b Over the frequency range 150 kHz to 80 MHz, field strengths should be less than 3V/m.

Recommended separation distances between portable and mobile RF communications equipment and the model

The model is intended for use in electromagnetic environment in which radiated RF disturbances is controlled. The customer or the user of the model can help prevent electromagnetic interference by maintaining a minimum distance between portable and mobile RF communications equipment (transmitters) and the model is recommended below, according to the maximum output power of the communications equipment.

Rated maximum output power of transmitter W	Separation distance according to frequency of transmitter m		
	150kHz to 80MHz $d=1.2 \times P^{1/2}$	80MHz to 800MHz $d=1.2 \times P^{1/2}$	800MHz to 2,7GHz $d=2.3 \times P^{1/2}$
0,01	0.12	0.12	0.23
0,1	0.38	0.38	0.73
1	1.2	1.2	2.3
10	3.8	3.8	7.3
100	12	12	23

For transmitters rated at a maximum output power not listed above, the recommended separation distance d in meters (m) can be estimated using the equation applicable to the frequency of the transmitter, where P is the maximum output power rating of the transmitter in watts (W) accordable to the transmitter manufacture.

NOTE I At 80 MHz - 800 MHz, the separation distance for the higher frequency rane applies.

NOTE II These guidelines may not apply in all situations. Electromagnetic propagation is affected by absorption and reflection from structures, objects and people.

The device has been tested and homologated in accordance with EN 60601-1-2 for EMC. This does not guarantee in any way that this device will not be affected by electromagnetic interference Avoid using the device in high electromagnetic environment.

11 Statement

Woodpecker reserves the right to change the design of the equipment, the technique, fittings, instruction manual and the content of the original packing list at any time without further notice. The pictures are only for reference. The final interpretation rights belong to Guilin Woodpecker Medical Instrument Co., Ltd. The appearance of the product was authorized patent, and counterfeit will be sued!

(Please refer to the packaging label for the date of manufacture.)

Scan and Login website
for more information



Guilin Woodpecker Medical Instrument Co., Ltd.
Information Industrial Park, Guilin National High-Tech
Zone, Guilin, Guangxi, 541004 P. R. China

Tel:

Europe Sales Dept.: +86-773-5873196

North/South America & Oceania Sales Dep.: +86-773-5873198

Asia & Africa Sales Dep.: +86-773-5855350 Fax: +86-773-5822450

E-mail: woodpecker@glwoodpecker.com, sales@glwoodpecker.com

Website: <http://www.glwoodpecker.com>

Cut along the dashed line

PT-B Dental Scaler and Air Polisher Warranty Card

Name of Customer		(I) For Distributor
Address Details		
Postal Code		
Tel		
Model		
Product No.		
Handpiece No.		
Purchase Date		
Contact Person		
Date	Maintenance Record	

PT-B Dental Scaler and Air Polisher Warranty Card

Name of Customer		(II) Return to Manufacturer
Address Details		
Postal Code		
Tel		
Model		
Product No.		
Handpiece No.		
Purchase Date		
Contact Person		
Date	Maintenance Record	

 Guilin Woodpecker Medical Instrument Co., Ltd.
Information Industrial Park, Guilin National High-Tech
Zone, Guilin, Guangxi, 541004 P. R. China

Europe Sales Dept. Tel: +86-773-5873196
North America, South America & Oceania Sales Dept. Tel:
+86-773-5873198
Asia & Africa Sales Dept. Tel: +86-773-5855350
Fax: +86-773-5822450
E-mail: woodpecker@glwoodpecker.com, sales@glwoodpecker.com
Website: http://www.glwoodpecker.com

Distributor:	Seal
--------------	------

 Guilin Woodpecker Medical Instrument Co., Ltd.
Information Industrial Park, Guilin National High-Tech
Zone, Guilin, Guangxi, 541004 P. R. China

Europe Sales Dept. Tel: +86-773-5873196
North America, South America & Oceania Sales Dept. Tel:
+86-773-5873198
Asia & Africa Sales Dept. Tel: +86-773-5855350
Fax: +86-773-5822450
E-mail: woodpecker@glwoodpecker.com, sales@glwoodpecker.com
Website: http://www.glwoodpecker.com

Distributor:	Seal
--------------	------

Warranty Instruction

I Period validity:

One year's free repair for the whole unit (except for the easily-consumed parts) from the date of purchase. Lifetime maintenance.

II Range of warranty:

Within the warranty period of validity, we are responsible for any troubles caused by quality problems or products technique and structure.

III The following are beyond our warranty:

1. The damage caused by disobeying the operation instruction or lack of the needed condition.
2. The damage caused by unsuitable operation or disassembly without authorization.
3. The damage caused by unadvisable transportation or preservation.
4. There isn't the seal of distributor or the warranty card isn't filled in completed.

Warranty Instruction

I Period validity:

One year's free repair for the whole unit (except for the easily-consumed parts) from the date of purchase. Lifetime maintenance.

II Range of warranty:

Within the warranty period of validity, we are responsible for any troubles caused by quality problems or products technique and structure.

III The following are beyond our warranty:

1. The damage caused by disobeying the operation instruction or lack of the needed condition.
2. The damage caused by unsuitable operation or disassembly without authorization.
3. The damage caused by unadvisable transportation or preservation.
4. There isn't the seal of distributor or the warranty card isn't filled in completed.

Harm of fake products

 and **DTE** are two brands of Guilin woodpecker medical instrument company. Recently, growing fake ultrasonic scaler handpieces, tips curing lights are produced and sold on the market, which do harm to users' interest. On this issue, We Woodpecker will crack down fake products and provide safe and secure medical instrument products.

1. Harm of fake ultrasonic scaler handpieces.

- 1.1 Fake handpieces with poor-designed inner structure can lead to frequent power leakage, which may cause medical accidents.
- 1.2 Material used on fake handpieces don't pass biocompatible test, which can easily lead to irritability and poisoning.
- 1.3 Fake handpieces have quality problems of overheating, non-vibration and cracking, which cause ultrasonic scalers out of order.
- 1.4 Fake handpieces can't be compatible with ultrasonic scalers, thus leading to circuit burn out.

2. Harm of fake scaler tips.

- 2.1 Fake tips are low in toughness, poor in resistance and easy to crack, thus easily cause medical accident.
- 2.2 Fake tips' screw threads are roughly processed, which can cause handpiece's screw loosening and cracking.
- 2.3 Material used on fake tips is inferior and easily rusting, which can cause infection of patient.
- 2.4 Fake tips have used problem of poor water-spraying, bad screw-thread fit and water leaking, which leads ultrasonic scalers work wrongly.

3. Harm of fake curing light.

- 3.1 Fake curing light's batteries can cause self-ignite, even explosion with poor-quality material and no complete charging management.
- 3.2 Light intensity of fake curing light is not constant, when battery level goes down under 60%, it would lead to incomplete solidification of resin, causing secondary dental caries.

